



Carbide dead centres according to works standard

Extension of our product range for STUDER* grinding machines



0.8 μm

Carbide dead centres

Technical features

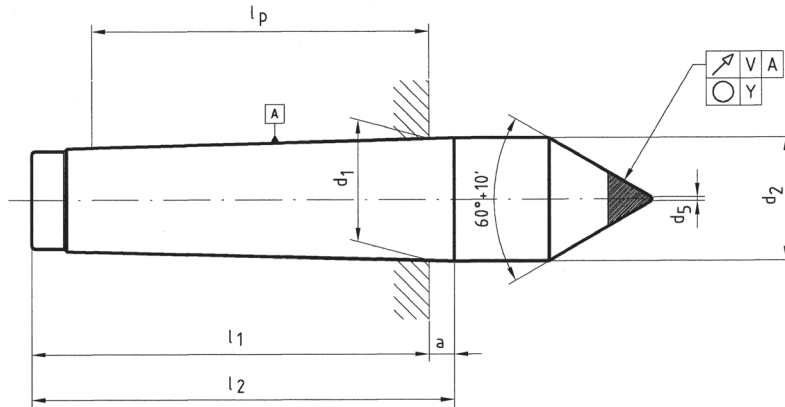

Excerpt from DIN 806, DIN 228 and BRUCKNER works standard (dimensions in mm)

MT	DIN							DIN	Bruckner works standard		
	d ₁	d ₂	d ₅	l ₁	l ₂	a	l _p	V	V	Z	Y* _{max}
2	17.780	18.0	0.8	64.0	69.0	5.0	54	0.01	0.003	0.003	0.0008
3	23.825	24.1	0.8	81.0	86.0	5.0	69	0.01	0.004	0.004	0.0008
4	31.267	31.6	1.0	102.5	109	6.5	87	0.01	0.004	0.005	0.0008

*For centres with centrebore Y = 0.001 mm



Roundness of the carbide Y
Out-of-roundness ≤ 0.0008 mm (0.8 μm)



Concentricity V
Very narrow eccentricity V of the 60° point to the taper shank according to table.



Taper shank tolerance Z
Maximum Morse taper error, taper increasing towards the large diameter along the tested length l_p (deviation of taper is ≤ AT4 according to DIN 228).

HRC

Hardened Morse taper
The taper shank is case-hardened for protection from damage.

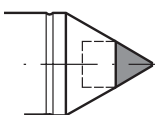

Regrinding line

Regrinding line
The useful end of the carbide is shown by the regrinding line for dead centres with carbide insert resp. by the braze line for centres with carbide ring.

Regrinding/Repair service (also for tools from other manufacturers)
We judge the centre's condition. You will get a survey report on the repair tasks.

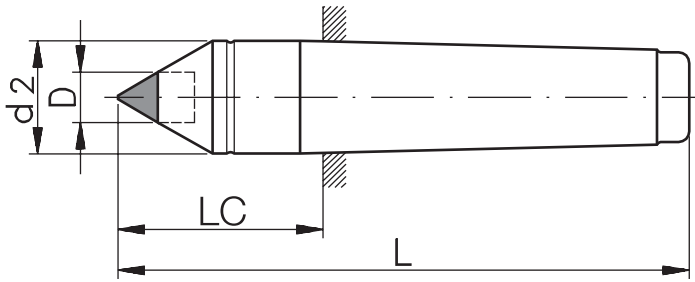

Form L, full centre 60°, out-of-roundness \square 0.8 μ m

MT	ID.No.	equal to STUDER* No.	D mm	d2 mm	LC mm	L mm
2	2802.15-94	0166.025	15	20	30	94
2	2802.15-110	0138.004	15	20	46.5	110.5
3	2803.15-117	-	15	26	36.5	117
3	2803.15-125	-	15	26	45	125.5
3	2803.20-117	0709.017	20	26	36.5	117
3	2803.20-125	0710.020	20	26	45	125.5
4	2804.25-160	2810.030	25	35	57.5	160

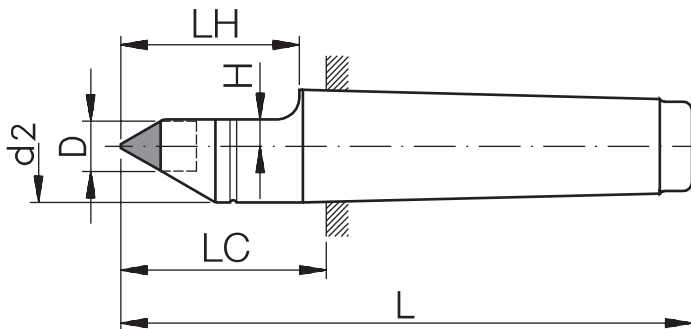

Form HS, extra flat height 60°, out-of-roundness \square 0.8 μ m

MT	ID.No.	equal to STUDER* No.	D mm	d2 mm	H mm	LH mm	LC mm	L mm
2	2812.15H2,5-97	0810.052	15	20	2.5	28	33	97
2	2812.15H2,5-110	0138.005	15	20	2.5	38.5	46.5	110.5
3	2813.11H1-150	-	11	24.1	1	63	69.5	150
3	2813.11H2-150	-	11	24.1	2	63	69.5	150
3	2813.11H3-150	-	11	24.1	3	63	69.5	150
3	2813.20H4-125	0710.021	20	26	4	36.5	45	125.5
3	2813.20H2-150	0710.045	20	26	2	55	69.5	150

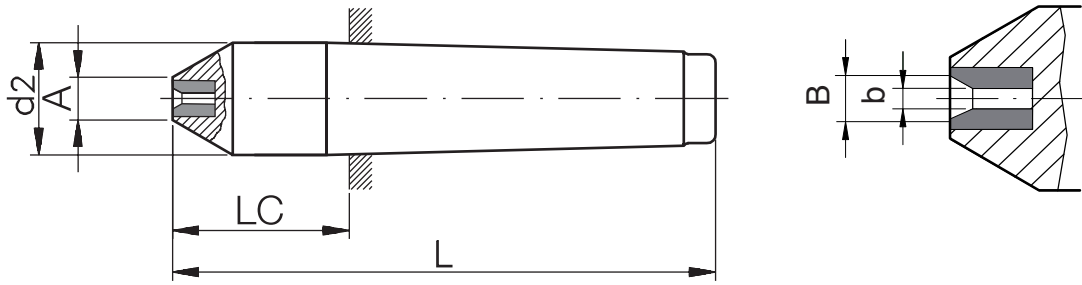

Form B, female centre with ground centrebore in the carbide, 60°, out-of-roundness \square 1.0 μ m

MT	ID.No.	equal to STUDER* No.	B mm	b mm	A mm	d2 mm	LC mm	L mm
2	2822.2,5x1-96	-	2.5	1	6	18	32	96
3	2823.2,5x1-120	-	2.5	1	6	24.1	39	120
3	2823.4x2-120	-	4	2	9	24.1	39	120

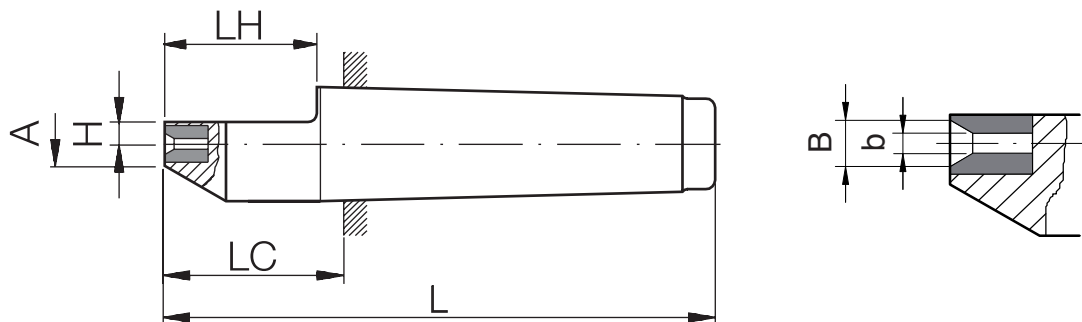

Form HB, with flat, female centre with ground centrebore in the carbide, 60°, out-of-roundness \square 1.0 μ m

MT	ID.No.	equal to STUDER* No.	B mm	b mm	A mm	d2 mm	H mm	LH mm	LC mm	L mm
2	2832.2,5x1H2-96	-	2.5	1	6	18	2	26	32	96
2	2832.4x2H2,5-96	-	4	2	9	18	2.5	26	32	96
3	2833.2,5x1H2-120	-	2.5	1	6	24.1	2	32	39	120
3	2833.4x2H2,5-120	-	4	2	9	24.1	2.5	32	39	120

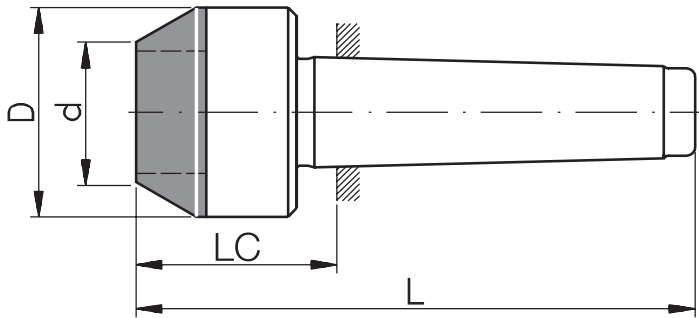

Form R, carbide ring 60°, out-of-roundness \square 0.8 μ m

MT	ID.No.	equal to STUDER* No.	D mm	d mm	LC mm	L mm
2	2802.28x13,5	0166.026	28	13.5	30	94
2	2802.38x23	0166.029	38	23	32	96
3	2803.28x13,5	0709.058	28	13.5	30.5	111
3	2803.38x23	0709.059	38	23	32.5	113

Special designs

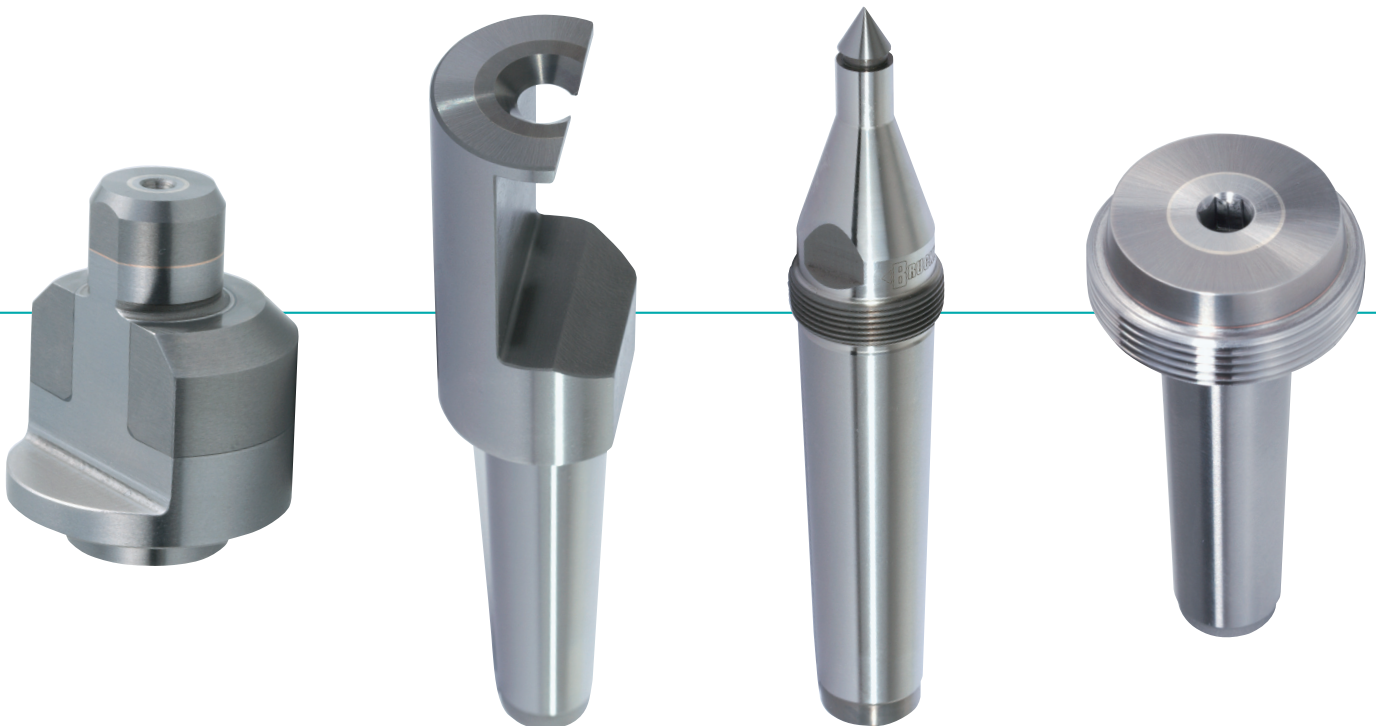

*Registered brand of the FRITZ STUDER AG, CH-Thun

> Our product range

- High-performance live centres
- High-performance bullnose live centres
- Dead centres
- Tailstock sleeves
- Face drivers type SM
- Face drivers type HS
- Special designs



Karl Bruckner GmbH
Precision Tools Manufacturer

P0 Box 31 46
D-71373 Weinstadt

Address:
Bruckwiesenstrasse 13
D-71384 Weinstadt-Grossheppach

Phone: +49 (0) 7151 9671-0
Fax: +49 (0) 7151 9671-23
e-mail: info@karlbruckner.de

www.karlbruckner.de